

# OCTA FLOOR

CLASSIC | ELEVATE | ECO

**DOUBLE FLOORS  
WITH A SYSTEM**

**DOWN  
TO  
EARTH**

## INTRO

Firmly grounded. Proven. A solid standing. We are all following the laws of gravity. No matter if we are standing, sitting or lying – there is always something beneath us. So we asked ourselves how a floor must be constructed so as to provide the best base for your exhibition booth or event. A floor that is easy to handle and flexible to use. Before, during and after installation. Here are our basic answers.



# STOCK PIL ED

**THE WORLD'S LARGEST FAIR  
GROUNDS ARE LOCATED IN  
HANNOVER, COVERING AN  
EXHIBITION AREA OF 496.000 M<sup>2</sup>.**

# CONTENT

---

<b>OCTAFLOOR floor systems</b>	<b>6</b>
<b>OCTACLASSIC FLOOR</b>	<b>8</b>
Technical features	10
Details	12
<b>OCTAELEVATE FLOOR</b>	<b>14</b>
Technical features	16
Details	18
<b>OCTAECO FLOOR</b>	<b>20</b>
Technical features	22
Details	24

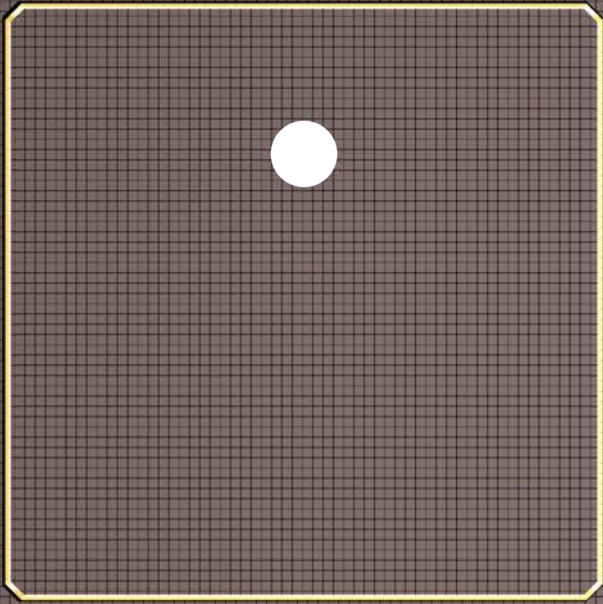

# 1 SUPPLIER 3 FLOORS ABSOLUTE FREEDOM

## FOR YOUR PROJECT

It's the product you don't see but so many need. It's the silent hero that makes all above it function and work. Working load limits of up to 20,000 kg per square meter. Water and weatherproof. Quick and easy to install. All this makes OCTAfloor more than just double floors. They are suitable for every project of any size. Indoors and outdoors. Individually adjustable to special shapes or uneven floors. With illuminated edges and edge guards. You are looking for a system that's not only down to earth and reliable, but also sustainable? We give you a choice of three.

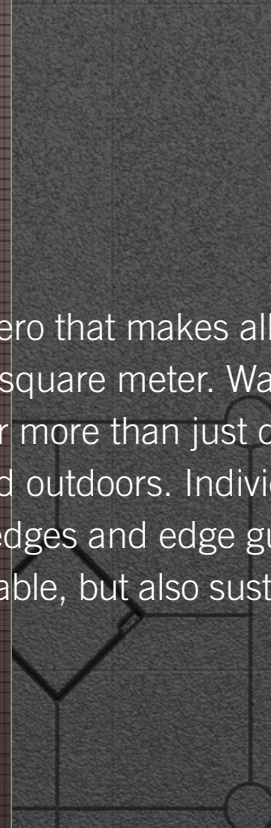
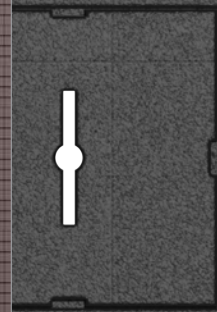
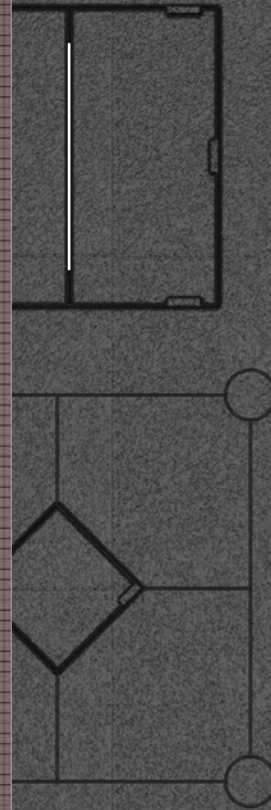

# OCTAFLOOR FLOOR SYSTEMS

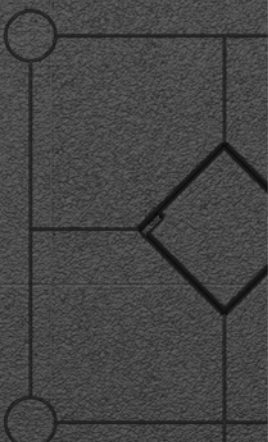
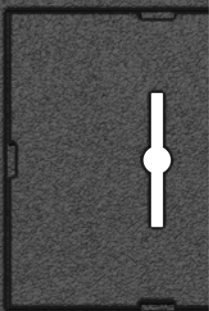
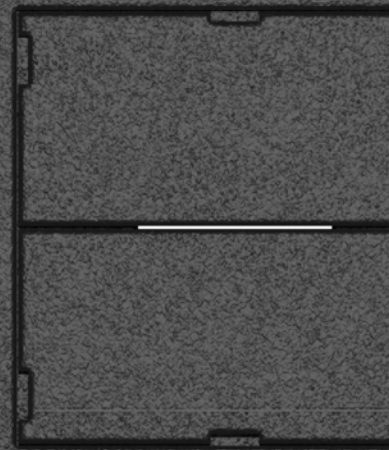
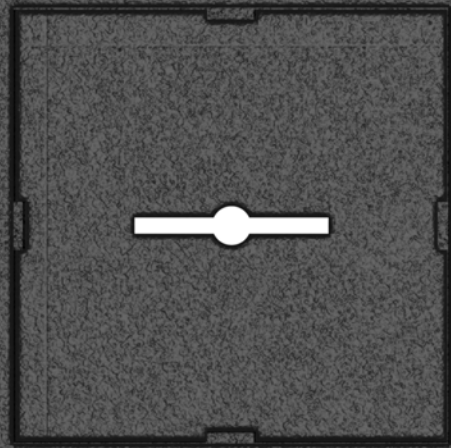
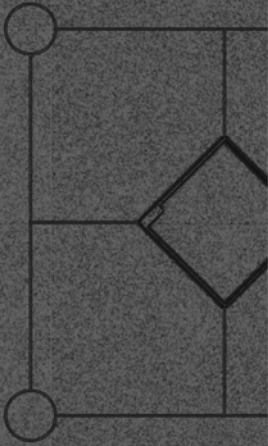



# APPROVED ADJUSTABLE LIGHTWEIGHT

**THE CLASSIC. MADE BY OCTANORM.**

A floor system that convinces with its reliability. Proven countless times. Individually adjustable floor panels and infinitely adjustable height – OCTAclassic floor combines flexibility and stability. You are looking for a light double floor system for your indoor events? You found it.



# OCTACLASSIC FLOOR



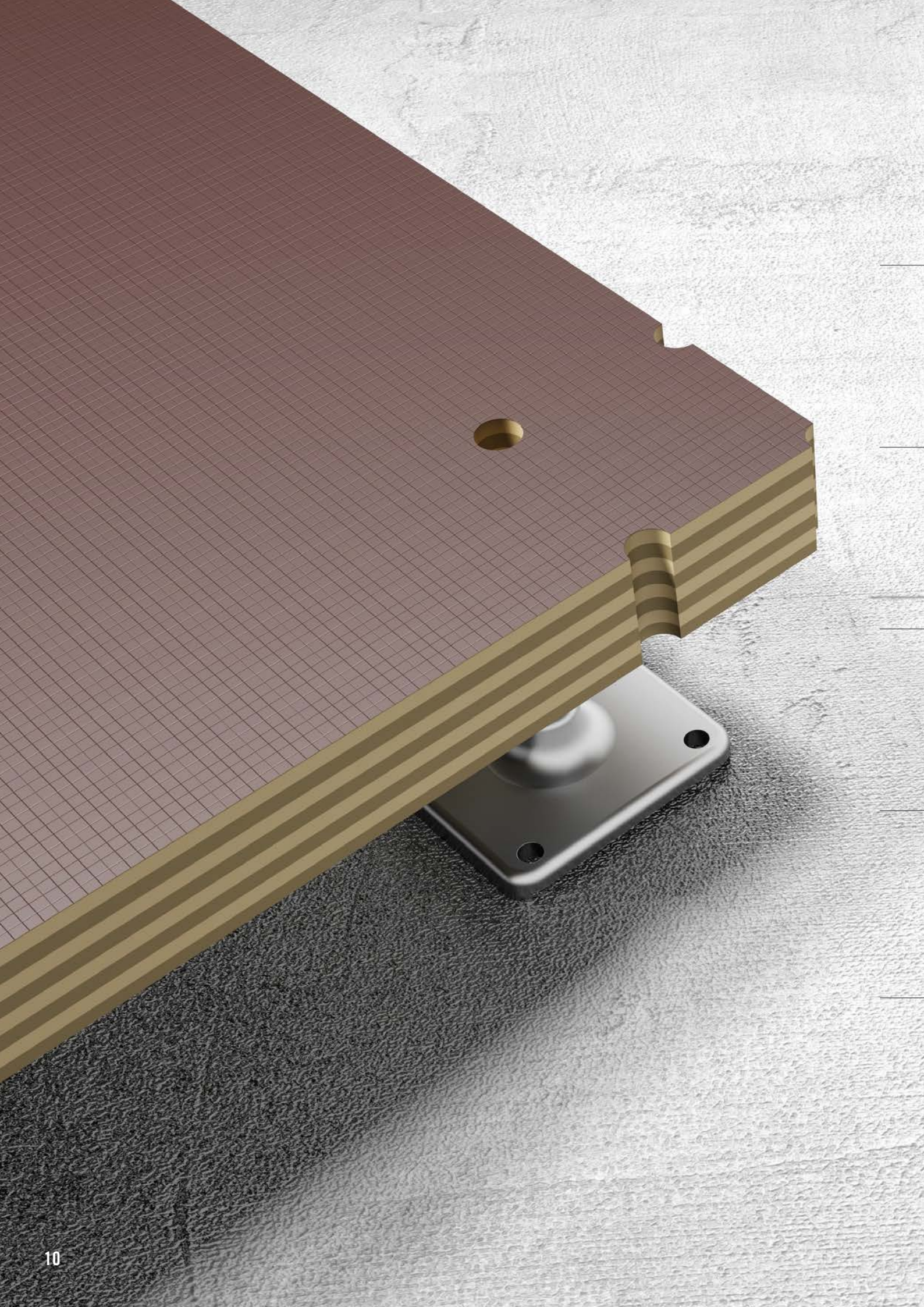

# TECHNICAL FEATURES

## OCTAclassic floor

up to  
5,000  
kg/m<sup>2</sup>

Working load

indoor

Use

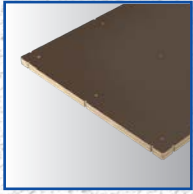

3 panel sizes

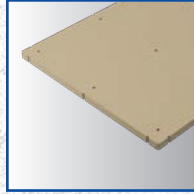

Individual panel



Different adjustable feet

1

Cable outlets per m<sup>2</sup>

4

Possible cable outlets per m<sup>2</sup>  
by rotating the panels

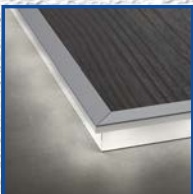

Illuminated edge guards  
possible



25 m<sup>2</sup> of floor panels on  
one pallet

### Up to 5,000 kg/m<sup>2</sup> working loads. Child's play.

The working load limit can be adjusted individually through the amount of feet installed. Depending on your requirements, 4 up to 9 feet can be installed to maximize the loading capacity.

### 3 panel sizes. Countless possibilities.

The standard sizes of our floor panels are 998 × 998 mm, 998 × 498, and 498 × 498 mm. But since you can cut the SP12 tile to your requirements, this does not restrict your freedom the slightest. Your floor is as individual as your exhibition stand.

### Stairs. Infinitely.

The system offers three different feet, two of which are infinitely variable: allowing for heights of 95 – 225 mm (including tile height).

### Stand out: get attention.

Illuminated edges make OCTAclassic floor stand out from the surrounding hall floor. A visual highlight created with minimum effort – visual trip protection included.

**Light weight. Easy handling.**

The OCTAclassic floor is the lightweight of our floor systems. It scores not just because of the infinitely adjustable height, but also because of the low weight. This allows for large platforms being moved even with small equipment.

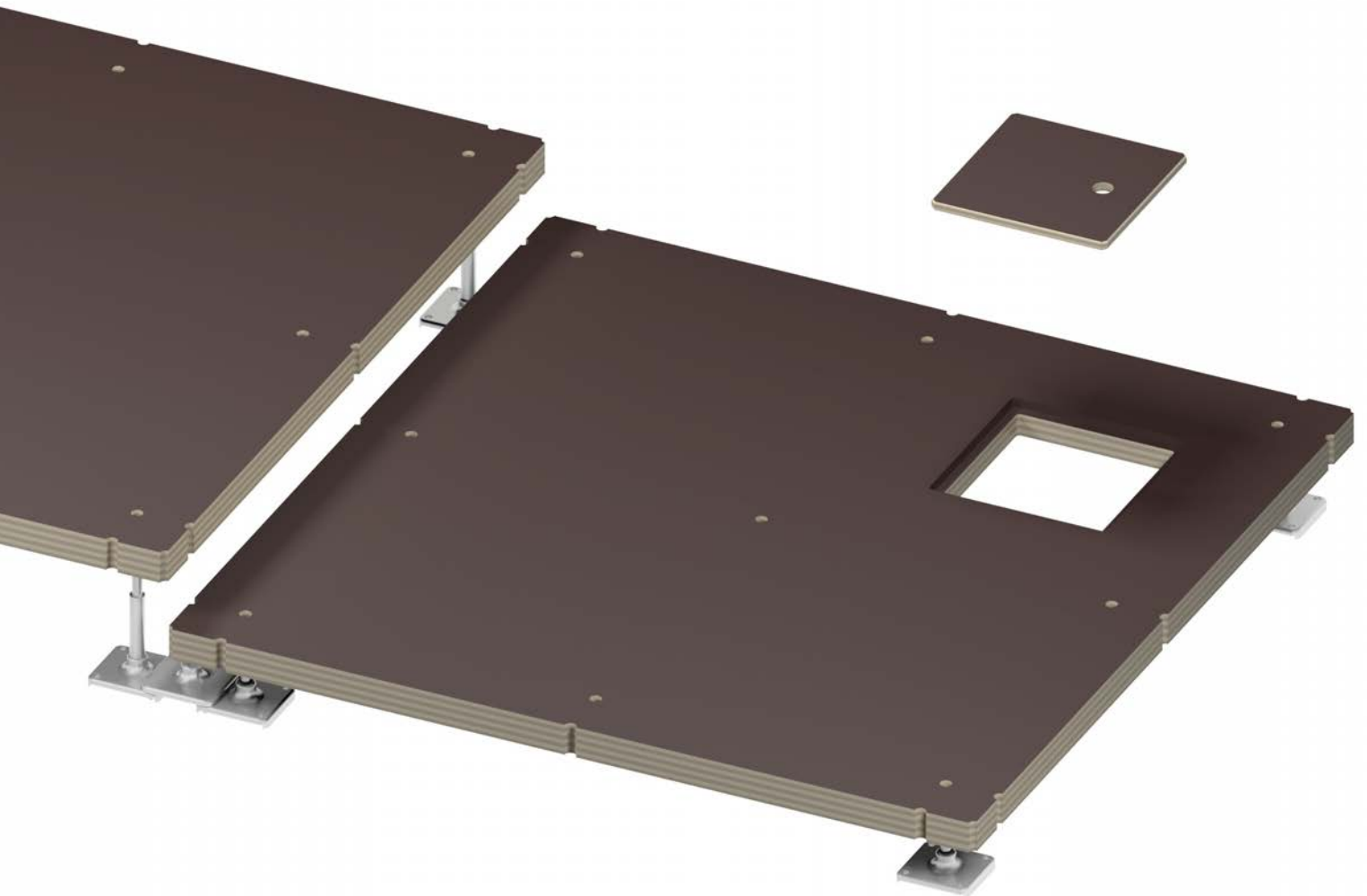

**The working load limit is increased with the amount of feet.**

The working load limit of the single panels can be adjusted individually to the requirements. You can increase your working load limit from 750 to 5,000 kg/m<sup>2</sup>.

## DETAILS

### OCTAclassic floor



#### **2 adjustable feet. Infinitely adjustable height.**

By combining the different feet, different infinitely adjustable landing heights are possible. Noise suppressors and anti-slip gumming ensure safety and provide unwanted footfall sound insulation.

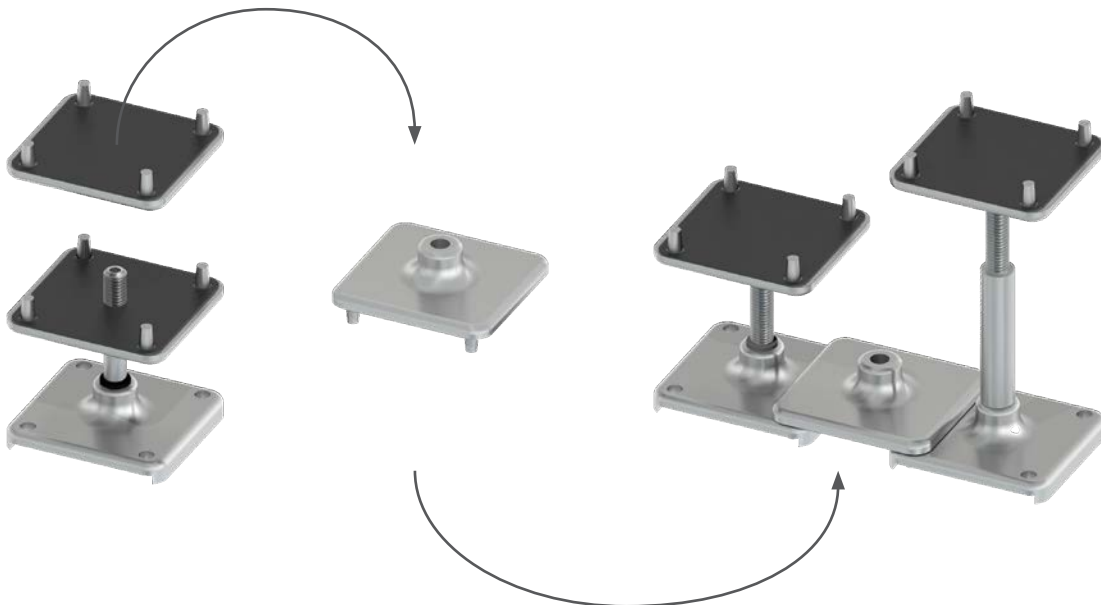



# **SIMPLE SUSTAINABLE VERSATILE**

**INDOORS & OUTDOORS. READY FOR USE WHEREVER NEEDED.**

OCTAelevate floor – simple and versatile. Suitable for all occasions, be it indoors or outdoors. The high amount of cable outlets allows you to quickly and easily install your cabling where you need it. Stackable feet allow height adjustments of individual panels. A floor system which can be universally used and is installed in little to no time.

# OCTAELEVATE FLOOR

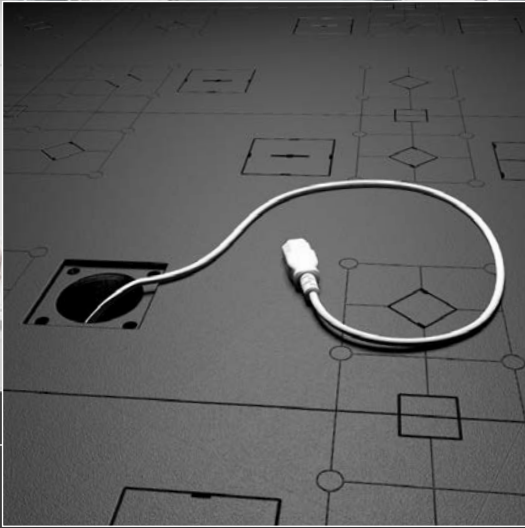

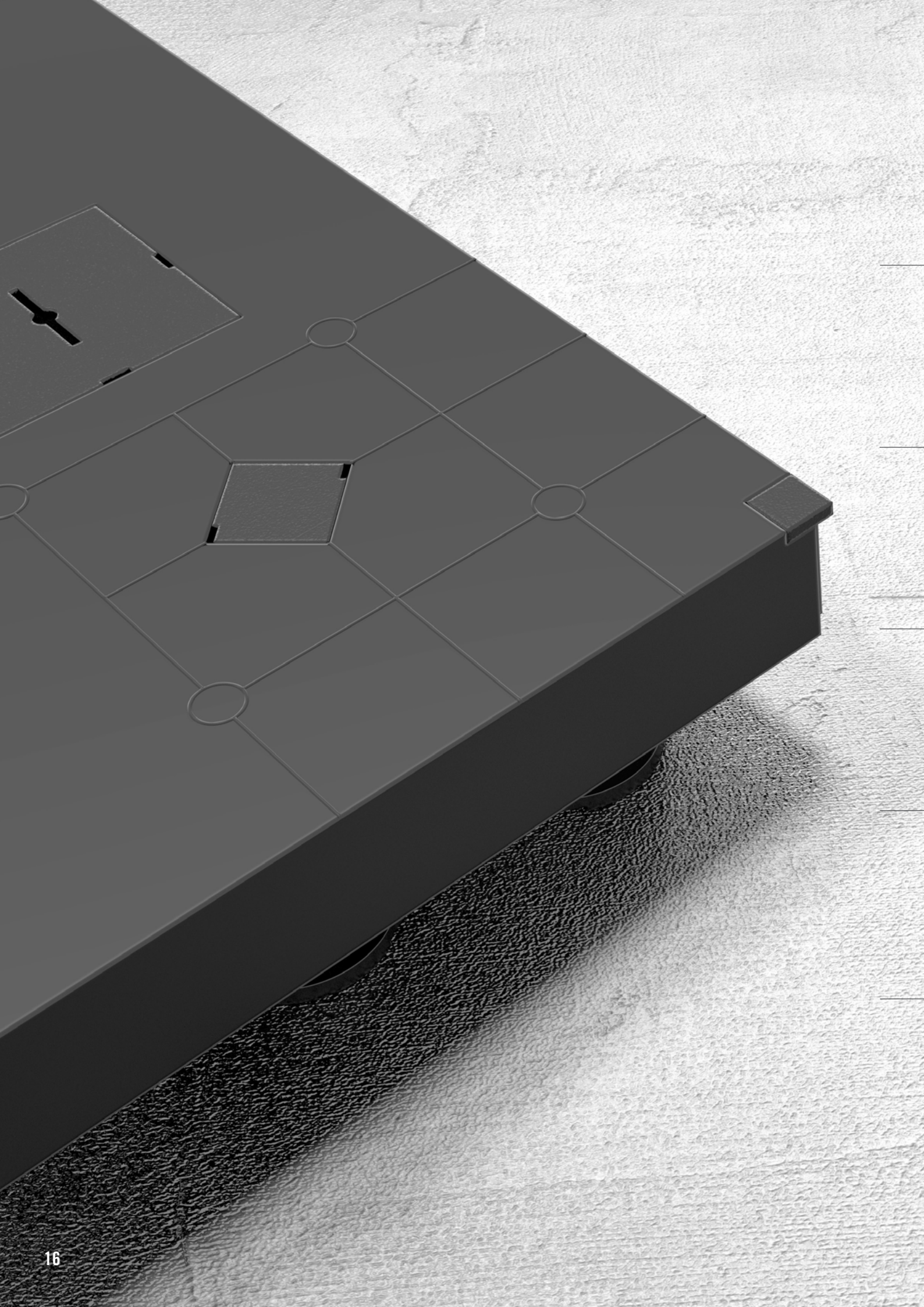



# TECHNICAL FEATURES

## OCTAelevate floor

up to  
4,000  
kg/m<sup>2</sup>

Working load

indoor  
outdoor

Use

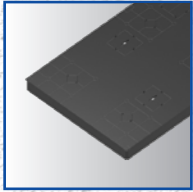

1 panel size  
(individual panel available)

100 %  
recycled  
material

Sustainability

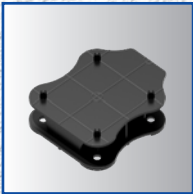

Stackable foot

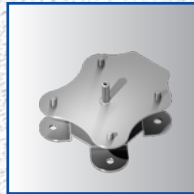

Adjustable foot

21

Cable outlets per m<sup>2</sup>

29

Possible cable outlets per m<sup>2</sup>  
by rotating the panels

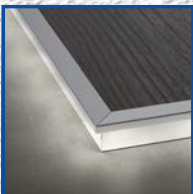

Illuminated edge guards  
possible



25 m<sup>2</sup> of floor panels on  
one pallet

### Use: indoors and outdoors.

The floor panel is made from weatherproof, recycled plastic, making it suitable for indoor and outdoor use. The material is nonsensitive to moisture and thermal fluctuation.

### No more cable tangle.

The standard floor panel is 998 × 499 mm and has 21 cable outlets per m<sup>2</sup>. The perfect solution even for last minute adjustments – without much hassle.

### Stacking. Easily.

The OCTAelevate floor comes with highly robust and easily stackable feet. Realize landing heights of up to 270 mm in 55 mm steps. Without any additional accessories.

### Compatibility.

The floor panels of OCTAclassic floors are combinable with the ones of OCTAelevate floor. The illuminated edges from the OCTAclassic floor can easily be used to make the OCTAelevate floor shine as well.

**Big areas, variable heights, quick installation.**

Only a few components are needed to lay down several square meters of floor in the blink of an eye. The respectively stackable and adjustable feet allow different landing heights. The lines on the feet and panels support the fast and exact positioning of the feet and ensure a fast build-up.

**DID YOU KNOW THAT OUR  
FLOOR SYSTEMS ARE  
100% RECYCLABLE?**



## DETAILS

### OCTAelevate floor

#### **Quick installation. Even with a lot of cables.**

The floor panel has a maximum 21 cable outlets per m<sup>2</sup>. Electric connections can be placed purposefully without any additional slots. This, in combination with the simple click-in system, ensures short installation times.

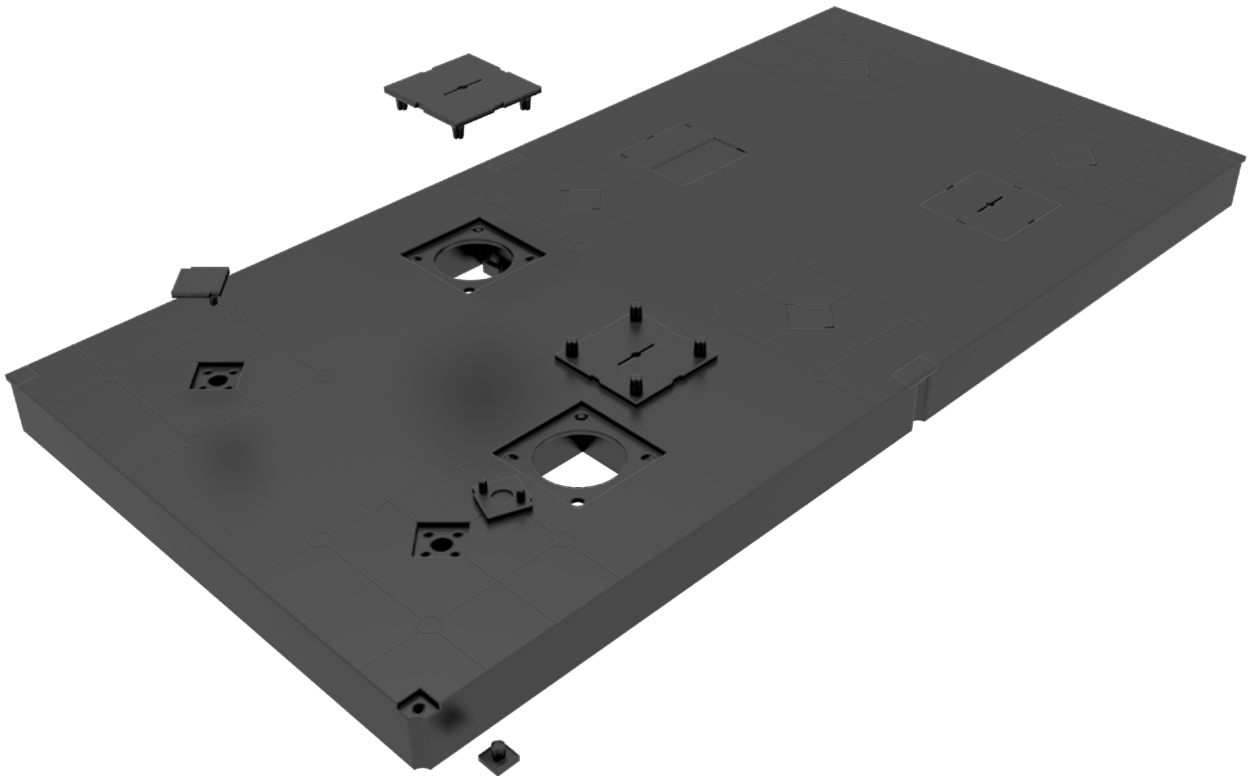

#### **2 feet. Stackable or adjustable.**

In 55 mm steps, up to four feet can be stacked to a total height of 270 mm. An adjustable foot allows infinite adjustments between 45 – 95 mm.





# QUICK EXTREMELY FLAT HEAVY DUTY

**BIG IMPACT IN LITTLE TIME**

Big areas, but little time? With OCTAeco floor you can realize big, heavy-duty areas in no time. Weights of up to 20,000 kg/m<sup>2</sup> are no problem. In any weather, since the event and exhibition floor is suitable for outside use. Save time and personnel. Be it cars or heavy machinery, the OCTAeco floor is always the right foundation. Again and again.

# OCTAECO FLOOR



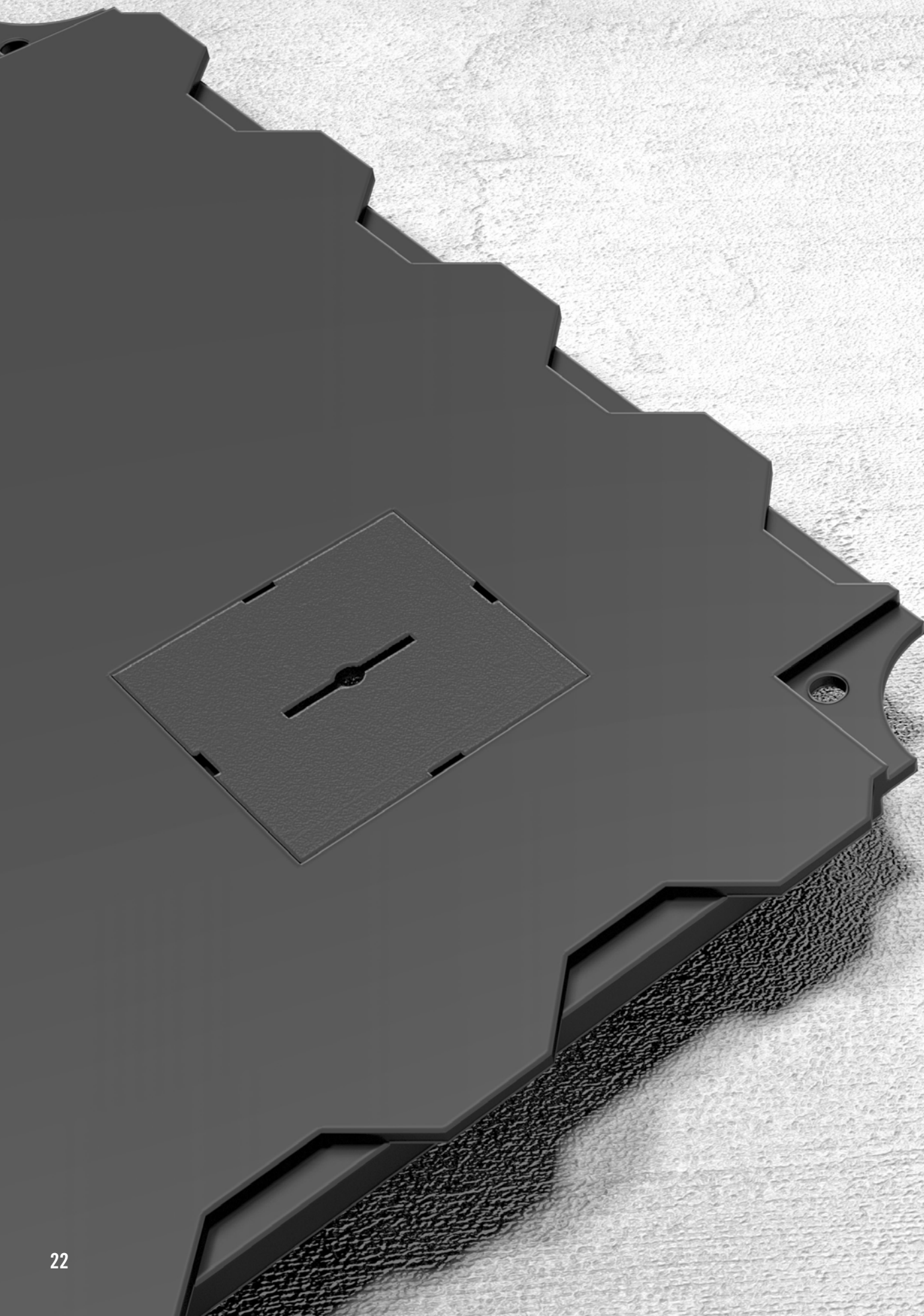

# TECHNICAL FEATURES

## OCTAeco floor

up to  
20,000  
kg/m<sup>2</sup>

Working load

indoor  
outdoor

Use

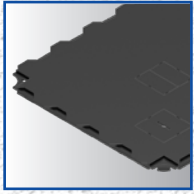

1 panel size

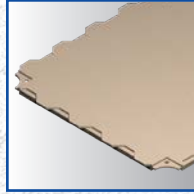

Individual panel

9

Cable outlets per m<sup>2</sup>

25

Possible cable outlets per m<sup>2</sup>  
by rotating the panels

100 %  
recycled  
material

Sustainability

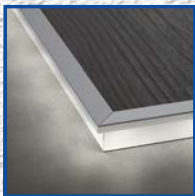

Illuminated edge guards  
possible



25 m<sup>2</sup> of floor panels on  
one pallet

### Big areas. Little time.

The OCTAeco floor's biggest advantage is the fast installation. Big areas – effortless.

### For heavy weights of up to 20,000 kg/m<sup>2</sup>.

The well thought-out design offers maximum stability, making the floor perfect for high loads. You can even drive on it. The material is nonsensitive to moisture and thermal fluctuation.

### Effortless assembly. Thanks to a simple connecting system.

The low weight in combination with the smart connector system allow for a quick and easy installation of your floor. Even with little personnel.

### Individuality. With a system.

The panels can be turned by 360°, allowing for a maximum of 25 possible cable outlets per m<sup>2</sup>. And if you need individually adjusted special panel shapes, OCTAeco floor also offers a panel that can be cut to size.

**The fastest among them all.**

Made from 100 % recycled plastic, OCTAeco floor has a lifetime of at least 10 years. The longevity in combination with the outstanding value for money result in a quick amortization of the system. Also, it is sustainable. And all this at a working load limit of up to 20 t/m<sup>2</sup>. So no worries driving your 7.5 t truck onto the freshly laid floor in the future.

**ON INCINERATION,  
POLYPROPYLENE BREAKS  
DOWN COMPLETELY INTO  
WATER AND CO<sub>2</sub>.**

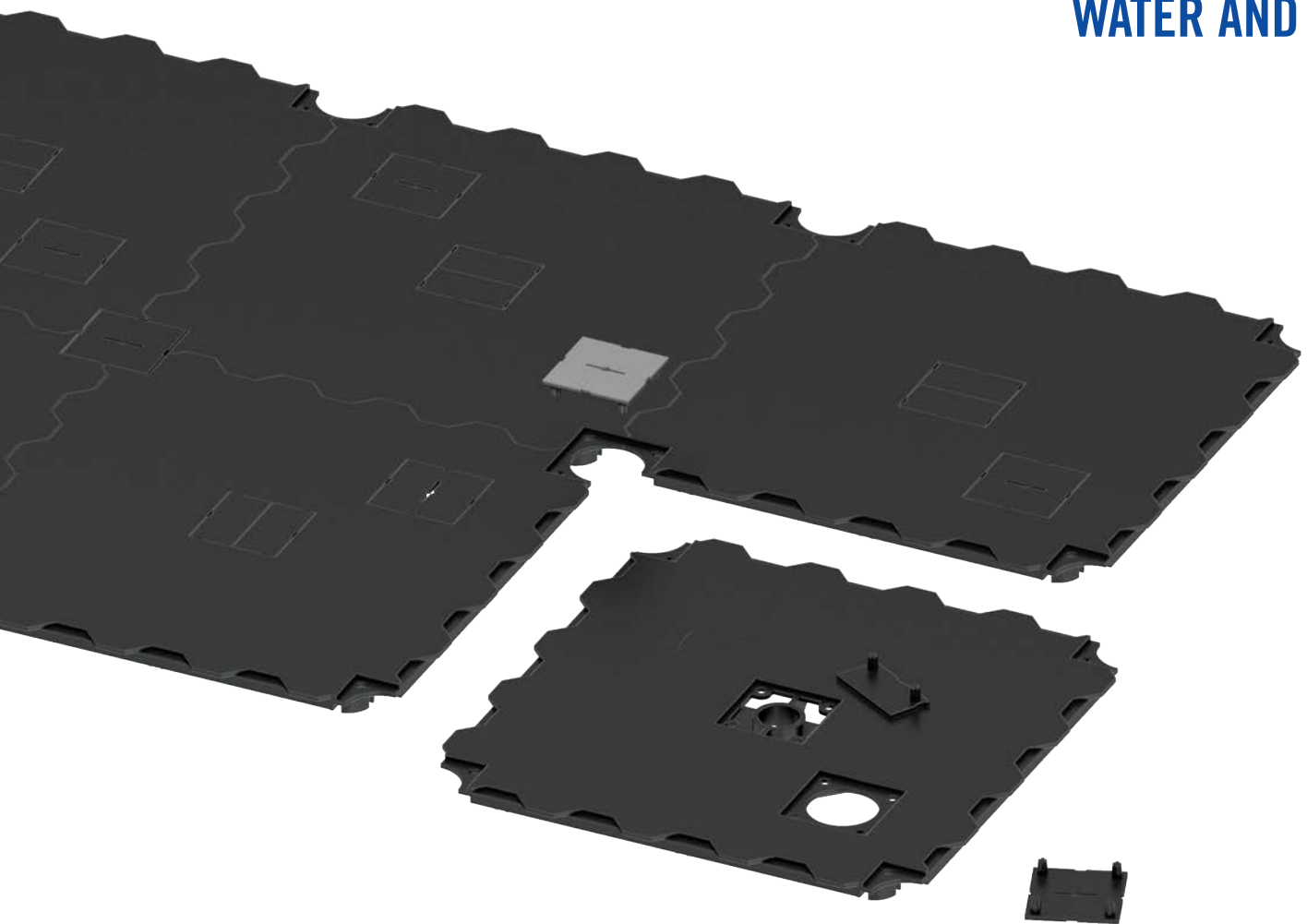



## DETAILS



### OCTAeco floor

**Intelligent transportation. Quick installation.**

You can transport up to 25 m<sup>2</sup> of floor panels on one pallet, keeping transportation easy. Just connect four panels to each other and stack them. Thanks to the low weight, those four-packs can be laid in one step. Saving valuable time.

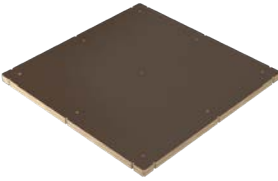

## ALL 3 FLOOR SYSTEMS AT A GLANCE

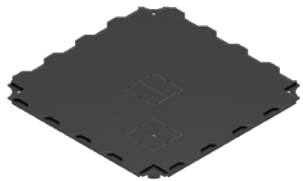
	<b>OCTACLASSIC FLOOR</b>	<b>OCTAELEVATE FLOOR</b>	<b>OCTAECO FLOOR</b>
			
<b>WORKING LOAD LIMIT</b>	up to 5,000 kg/m <sup>2</sup>	up to 4,000 kg/m <sup>2</sup>	up to 20,000 kg/m <sup>2</sup>
<b>MATERIAL</b>	wood	polypropylene	polypropylene
<b>WATER AND WEATHERPROOF</b>	water-resistant	yes (outdoor)	yes (outdoor)
<b>MINIMUM HEIGHT</b>	95 mm	105 mm	43 mm
<b>MAXIMUM HEIGHT</b>	225 mm (foot + panel)	270 mm (4 feet + panel)	43 mm
<b>ADJUSTABLE HEIGHT</b>	infinitely	55 mm steps/infinitely	—
<b>CABLE OUTLETS / M<sup>2</sup></b>	1	21	9
<b>POSSIBLE CABLE OUTLETS / M<sup>2</sup> BY ROTATING</b>	4	29	25
<b>WEIGHT / M<sup>2</sup></b>	approx. 11 kg	approx. 22.5 kg	approx. 12 kg
<b>ASSEMBLY TIME</b>	+	++	+++
<b>SUSTAINABILITY</b>	++	+++	+++

# OVERVIEW

## OCTAfloor systems

### Advantages over traditional chipboard flooring:

- floor pays off after just a few use
- sustainability – no waste due to repeated usage
- shortest set-up times thanks to system design
- easy assembly and reduced staff requirement
- simple laying of cables through cable outlets and ground clearance
- floor systems can be rented or leased







Werkstattausstattung

Kundenratgeber  
Transporter

Kundendienst

S78ES mateco 21081043  
miet... mateco  
www.mateco.de

miet... mateco  
S 78 E S 21081040  
miet... mateco  
www.mateco.de



EXHIBITION SYSTEMS  
PROJECT SOLUTIONS  
PRESENTATION  
INTERIOR DESIGN  
CLEANROOM SYSTEMS



---

**OCTANORM® Germany**  
**Head Office**

Raiffeisenstraße 39  
70794 Filderstadt  
T. +49 711 77003-0  
F. +49 711 77003-53  
info@octanorm.de  
www.octanorm.com

---

**EUROPE**

**OCTANORM® Belgium**  
T. +32 2 344 9880  
www.octanorm.be

**OCTANORM® France**  
T. +33 1 4695 5406  
www.octanorm.fr

**OCTANORM® UK**  
T. +44 20 85 45 2945  
www.octanorm.co.uk

**OCTANORM® Hellas**  
T. +30 2310 79 6521  
www.octanorm.gr

**OCTANORM® Italia**  
T. +39 02 9645 1966  
www.formulaotto.it

**OCTANORM® Nederland**  
T. +31 50 309 5133  
www.octanorm.nl

**OCTANORM® Polska**  
T. +48 22 773 0350  
www.octanorm.pl

**OCTANORM® Adria**  
T. +386 590 56301  
www.octanormadria.com

**OCTANORM® Espana**  
T. +34 930 019 424  
www.octanorm.es

**OCTANORM® Nordic**  
T. +46 8 621 6500  
www.octanorm.se

**OCTANORM® Russia**  
T. +7 495 565 7920  
www.octanorm.ru

---

**AMERICA**

**OCTANORM® North America**  
T. +1 770 7 32 1520  
www.octanormna.com

**OCTANORM® México**  
T. +52 55 5804 6325  
www.octanorm.com.mx

**OCTANORM® Brasil**  
T. +55 11 3807 2552  
www.octanorm.com.br

**OCTANORM® Argentina**  
T. +54 11 43 12 4000  
www.octanorm.com.ar

---

**AFRICA**

**OCTANORM® South Africa**  
T. +27 11 433 2010  
www.octanorm.co.za

---

**MIDDLE EAST**

**OCTANORM® Emirates**  
T. +971 4 340 6888  
www.octanormemirates.net

---

**AUSTRALIA**

**OCTANORM® Australia**  
T. +61 3 8773 8550  
www.octanorm.com.au

---

**ASIA**

**OCTANORM® Japan**  
T. +81 45 511 8144  
www.octanorm.jp

**OCTANORM® China**  
T. +86 512 6283 3336  
www.octanorm.cn